

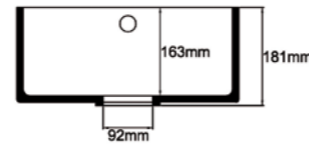

lavanto® – SPÜLEN AUS MINERALWERKSTOFF

ISEO

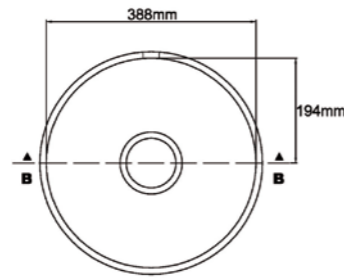

Beschreibung

Best.-Nr.

mit Überlauf-Fräsung inkl. Überlaufset

LS388C-H-0

ohne Überlauf-Fräsung

LS388C-H-1

CALDO

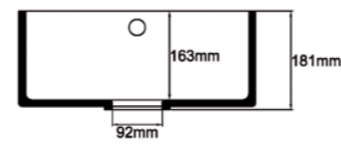
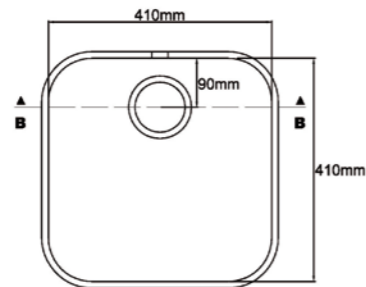

Beschreibung

Best.-Nr.

mit Überlauf-Fräsung inkl. Überlaufset

LS410C-H-0

ohne Überlauf-Fräsung

LS410C-H-1

VICO

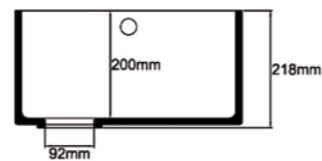
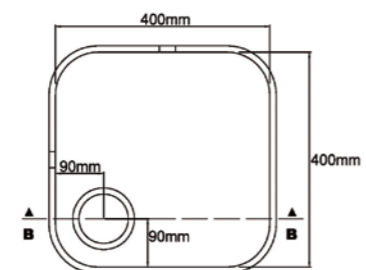

Beschreibung

Best.-Nr.

Einheit

mit Überlauf-Fräsung inkl. Überlaufset

LS400C-H-0

ohne Überlauf-Fräsung

LS400C-H-1

lavanto® – SPÜLEN AUS MINERALWERKSTOFF

ORTA

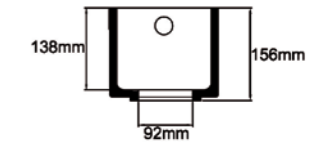
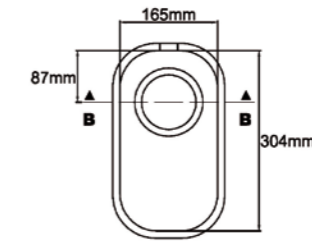

Beschreibung

Best.-Nr.

mit Überlauf-Fräsung inkl. Überlaufset

LS304C-H-0

ohne Überlauf-Fräsung

LS304C-H-1

FONDI

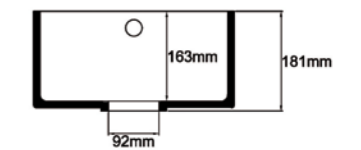
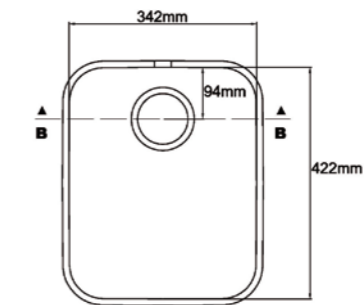

Beschreibung

Best.-Nr.

mit Überlauf-Fräsung inkl. Überlaufset

LS422C-H-0

ohne Überlauf-Fräsung

LS422C-H-1

GARDA

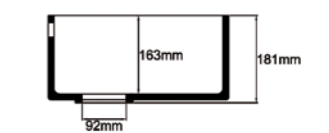
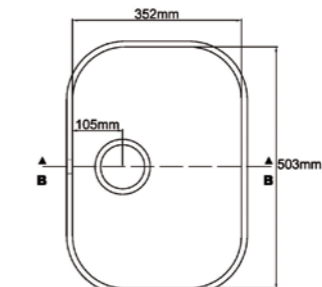

Beschreibung

Best.-Nr.

mit Überlauf-Fräsung inkl. Überlaufset

LS503C-H-0

ohne Überlauf-Fräsung

LS503C-H-1